



motorola



USER'S GUIDE

**Smart Nursery
Humidifier+**

Model: MBP83SN

The features described in this guide are subject to modifications without prior notice.

Welcome...

to your new Motorola Humidifier+!

Thank you for purchasing your new Motorola Smart Humidifier+.

The Humidifier+ is designed to let you manage and maintain it while at work, on the road and on vacation via "Hubble Connect for Smart Nursery" App. Featuring evaporative cool mist technology, the Humidifier+ is capable of humidifying your room for up to 8 hours. It releases silver ion that kill germs and ensure hygienic humidification.

Please keep your original dated sales receipt for your records. For warranty service of your Motorola product, you will need to provide a copy of your dated sales receipt to confirm warranty status. Registration is not required for warranty coverage.

For product related questions, please call:

+44 (0) 844 557 0890 (UK only)*

**Calls cost 7p per minute plus your telephone company's access charge*

+44 (0) 8187 62092 (ROI)

On the Web: www.motorolahome.com/support

This User's Guide has all the information you need to make the most out of your product.

Please read the Safety Instructions on page 5 before you install the unit.

Inside the Box

- 1 x Humidifier+ with Air Filter installed
- 1 x Power Adapter
- 1 x Water Filter
- 1 x Mist Outlet
- 1 x Quick Start Guide

Overview of the Humidifier+

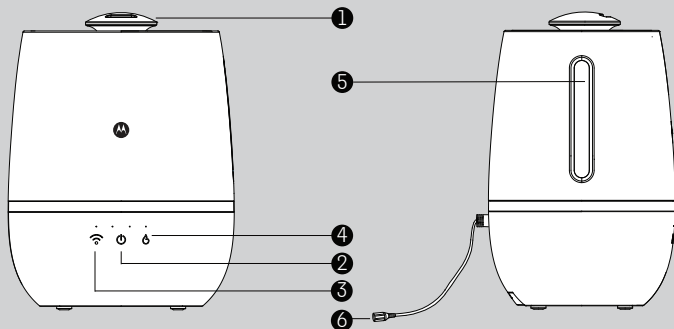





1. Mist Outlet
You need to plug in the Mist Outlet before use.
2. Mist On/Off button 
Toggle to turn the mist On/Off.
The backlight turns red when the water level in the chamber is low.
3. Pair key 
By default, the unit enters Wi-Fi® registration mode when it is first powered on.
To re-register the unit, tap the pair key  until the backlight blinks.
4. Mist Level Control button 
Tap the button to control the volume of mist output.
There are 4 user selectable levels.
5. Water Level Indicator
This is for visual check of the water level.
6. Power Port
For connecting the power adapter.



Table of contents

| | | |
|-----|--|----|
| 1. | Safety Instructions..... | 5 |
| 2. | System Requirements..... | 6 |
| 3. | Getting Started | 7 |
| 3.1 | Fill up the Water Tank and Install Water Filter | 7 |
| 3.2 | Connect Humidifier+ to Power Supply | 9 |
| 4. | User Account and Humidifier+ Setup on Android™ Devices / iPhone®/ iPad® | 10 |
| 4.1 | Download Hubble Connect for Smart Nursery App..... | 10 |
| 4.2 | Run Hubble Connect for Smart Nursery App on Android™ device / iPhone® / iPad® | 11 |
| 4.3 | Add Humidifier+ to your Smart Nursery account..... | 12 |
| 5. | Overview of Hubble App | 15 |
| 6. | Recommendations for Use and Care | 16 |
| 7. | Troubleshooting..... | 17 |
| 8. | Disposal of the Device (Environment) | 20 |
| 9. | General Information..... | 21 |
| 10. | Technical Specifications | 26 |

1. Safety Instructions

WARNING

This product is compliant with all relevant electromagnetic field standards and is, when handled as described in the User's Guide, safe to use. Therefore, always read the instructions in this User's Guide carefully before using the device.

- The humidifier is intended for indoor use only. Do not operate the humidifier outdoors.
- Always ensure that there is water in the water tank before operating the humidifier.
- Use only clean, cool water to fill the water tank.
- Place the humidifier on a smooth, level, waterproof surface that is elevated off the ground.
- Do not install the humidifier near children, walls, furniture and electrical appliances.
- Always handle the humidifier with dry hands to avoid electric shock.
- Do not operate the humidifier with a damaged cord or plug.
- Unplug the humidifier when not in use.
- Do not cover the mist outlet on the humidifier or insert objects into the mist outlet.
- Do not leave the humidifier in a closed room as the air could become saturated and leave condensation on walls or furniture.
- Leave room door partially open when the humidifier is being operated.
- This product is not a toy. Do not allow children to play with it.
- Keep this User's Guide for future reference.

Important guidelines for installing Humidifier+

- Use of other 2.4 GHz products, such as other wireless networks, Bluetooth® systems or microwave ovens may cause interference with this product. Keep the humidifier away from these types of products, or turn them off if they appear to be causing interference.
- Always ensure that you have a good Wi-Fi® connection available.
- Place the humidifier on a smooth, level surface, such as a table.

2. System Requirements

Smartphones/Tablets: Android™ and iOS® only.

System Requirement: iOS 8.0, Android™ 4.2 or above

For more information please visit: <https://hubbleconnected.com/requirements>

3. Getting Started

3.1 Fill up the Water Tank and Install Water Filter

Important:

Do not operate the humidifier without water in the water tank.

Make sure that the humidifier is unplugged from the mains power socket before removing the water tank.

ALWAYS use fresh cool water for the water tank.

1. Remove the mist lid from the top of the humidifier and plug the mist outlet into the lid.

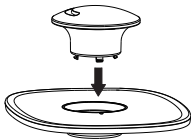

2. Lift up the handle on top of the water tank and remove the water tank from the humidifier base.



3. Snap the handle back into place, then turn the water tank upside down, remove the tank cap by twisting it counter clockwise.





4. Fill the water tank with clean, cool water and replace the tank cap by turning it clockwise until tight.

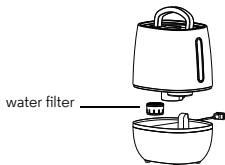

5. Install the water filter to the humidifier base, then replace the water tank on the humidifier base. Ensure that the water tank is firmly seated.



6. Attach the mist lid back to the humidifier, then connect one end of the power adapter into the power port on the humidifier and the other end to the mains power socket.

The  Mist On/Off LED will light up. Tap the Mist On/Off key  to turn mist On.

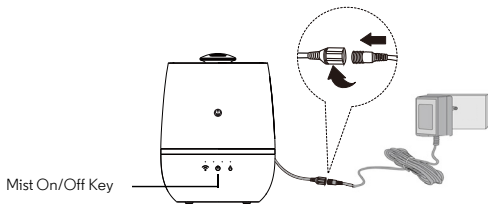

3.2 Connect Humidifier+ to Power Supply

1. Connect one end of the power adapter into the power port on the humidifier and the other end to the mains power socket.
2. The  Mist On/Off LED will light up.

4. User Account and Humidifier+ Setup on Android™ Devices / iPhone® / iPad®

What you need

- Humidifier+
- Device with Android™ system / iPhone® / iPad®

How Does It Work?



When a user tries to access Humidifier+, our **Smart Nursery** server authenticates the user's identity and permits access.

4.1 Download Hubble Connect for Smart Nursery App

- Go to Google Play™ Store to search for **Hubble Connect for Smart Nursery**.
- Download **Hubble Connect for Smart Nursery** App and install it on your Android™ device
- Or
- Go to App Store to search for **Hubble Connect for Smart Nursery**.
- Download **Hubble Connect for Smart Nursery** App and install it on your iPhone® / iPad®.

4.2 Run Hubble Connect for Smart Nursery App on Android™ device / iPhone® / iPad®

- Ensure that your Android™ Device / iPhone® / iPad® is connected to the Wi-Fi® router or mobile network.
- Run **Hubble Connect for Smart Nursery** App, tap **SIGNUP** and follow the in-app instructions to create your **Smart Nursery** Account. By signing up, you agree to our Terms & Conditions. (P1 & P2)

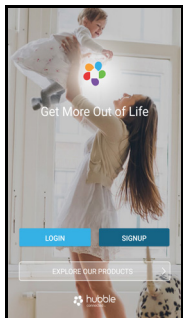

P1

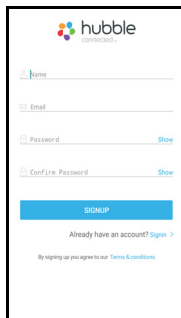

P2

Note

If you already have a **Smart Nursery** App account, please tap **LOGIN** by entering your account information and go to the next steps.

4.3 Add Humidifier+ to your Smart Nursery account

- Tap on **Humidifier** to enter Humidifier+ setup mode. (P3)

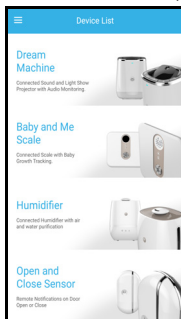

P3

- Tap on **Skip to Setup**, then tap **Next** to search for Humidifier+. (P4 & P5)

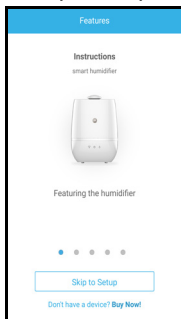

P4

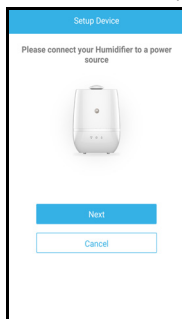

P5

- The device SSID can be found on your Android™ Device / iPhone® / iPad®. Tap the SSID to confirm. (P6)

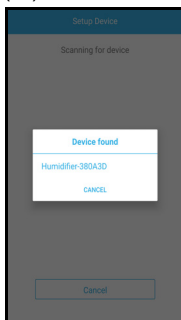

P6

- Humidifier+ is detected. Tap **Next** to proceed to the next step. (P7)
- You need a Wi-Fi® network to connect to your Humidifier+. Tap **Search** to start network searching. (P8)

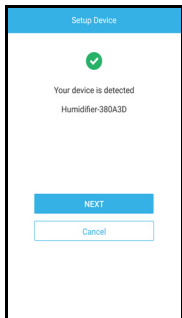

P7



P8

- Select a Wi-Fi® network from the network list, enter Wi-Fi® password and then tap **Submit**. (P9)

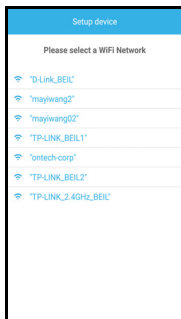

P9

- It will take a few minutes for Humidifier+ to connect to the Wi-Fi® network. Tap **Get Started** when Humidifier+ is successfully connected to **Hubble Connect for Smart Nursery** App. (P10 & P11)

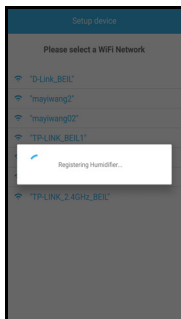

P10

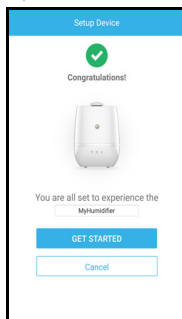





P11

Note

If you fail to complete the setup process, tap the pair key  on Humidifier+ until the backlight blinks to enter registration mode and repeat the above steps again.

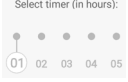
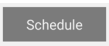
5. Overview of Hubble App

| | | |
|---|---------------------------------------|---|
|  | Mist On/Off | <ul style="list-style-type: none"> • Tap to switch on and off the Humidifier function. |
|  | Mist Output Level | <ul style="list-style-type: none"> • Tap to select Mist output level (1 -4). |
|  | Select Timer (in hours) | <ul style="list-style-type: none"> • Tap to switch on and off. Then select the operation hours from 1 to 12 hours. |
|  | Humidifier Schedule | <ul style="list-style-type: none"> • Select the specific calendar day for the Humidifier to operate. |
|  | Low Water Level Alert | <ul style="list-style-type: none"> • Message pops up when the water inside the reservoir reaches low limit. |
|  | Water Filter Replacement Alert | <ul style="list-style-type: none"> • Message pops up when water filter replacement is needed. |

6. Recommendations for Use and Care

- Empty the water tank, wipe all surfaces dry, and refill the water in the humidifier daily to reduce any growth of microorganisms; follow the instructions in “Fill up the Water Tank and Install Water Filter” on page 7 when changing water in the Humidifier. Be sure you unplug the humidifier from the mains power socket first.
- Use water with low mineral content, such as bottled water labelled with "distilled" to prevent the build-up of scale and the dispersal of minerals into the air. Even though distilled water still contains some minerals, it has lower mineral content than most tap water.
- Do not humidify to indoor relative humidity levels exceeding 50 percent. Higher humidity levels may encourage the growth of biological organisms in the home. Hygrometers, available at local hardware stores, may be used to measure humidity levels. If water condenses on windows, walls, or pictures, relocate the humidifier, lower its humidistat setting, or reduce its use.
- Do not let the area around the humidifier to become damp or wet. If dampness occurs, turn the output volume of the humidifier down. If the humidifier output volume cannot be turned down, use the humidifier intermittently. Do not let absorbent materials, such as carpeting, drapes, or tablecloths, to become damp.
- Clean the humidifier, as directed, at the end of the humidifying season or when the product will not be in frequent use. Before storage, make sure all the parts are dry. Dispose of all used demineralization cartridges, cassettes, or filters. Store the humidifier in a dry place. After storage, clean the humidifier again and remove any dust on the outside.
- Stop using your humidifier and contact your physician if you have respiratory symptoms which you believe are associated with periods of use of your humidifier, even if you are following maintenance directions. There may be bacteria growth if water remains in the water tank for more than 24 hours. As such, clean the humidifier daily.
- Every effort has been made to ensure high standards of reliability of your humidifier. However, if something does go wrong, please do not try to repair it yourself - contact Customer Service for assistance.

7. Troubleshooting

| Problem Category | Problem Description / Error | Solution |
|---------------------|--|---|
| Account | I am unable to login even after registration. | Please check your user name and password. |
| Account | I receive an error message saying: "E-mail ID is not registered". | Please ensure that you have registered with us. Tap Sign in to create an account. |
| Account | What do I do if I forget my password? | Click on the "Forgot Password" link on https://app.hubbleconnected.com/#lostpassword OR on your Android™ or iOS application. An e-mail will be sent to your registered e-mail address. |
| Account | I am unable to receive a new password although I have used the "Forgot password" option. | <ol style="list-style-type: none"> 1. The e-mail might have been sent to your Junk Mail Folder. Please check your Junk Mail Folder. 2. There might be a delay in getting your e-mail. Please wait a few minutes and refresh your e-mail account. |
| Connectivity Issues | I get a message: We are having problems accessing your Device. This could be due to the lack of an internet connection. Please wait and try again later. | <ol style="list-style-type: none"> 1. Please try again in a few minutes. This could be because of any issue with your internet connection. 2. If the problem remains, please restart your Device to check if this fixes the problem. 3. Please restart your Wireless Router. |



| | | |
|---------------------|---|---|
| Connectivity Issues | I am not able to access my Device. | Please check if the Device is within Wi-Fi range. If the LED on your Device is flashing slowly, please try to move the Device closer to the router for better Wi-Fi connectivity and try again. |
| Setting Up | While I am adding a new Device to my account, I am not able to find any Device to add. | If you are trying to add a Device which has previously been added into your account or another account, you will first have to reset the Device. This can be done by tapping the PAIR button twice. |
| Setting Up | During setup on devices for Android™ and iOS, I am not able to find my Device during the last step and the setup fails. | Please reset the Device to setup mode and try again. Tap the PAIR button on the Device until you hear a beep. Wait for a minute for the Device to restart. When the Device LED is flashing, this indicates that it is in setup mode. Now restart the setup from your smartphone again. |
| General | Which platforms are supported for accessing my Device? | Minimum requirement: Android™ 4.2 iPhone /iPad iOS version 8.0 |



| | | |
|-----------|---|---|
| General | How do I download the App for Android™ and iOS devices? | <p>Android™:</p> <ul style="list-style-type: none">- Open the Google Play on your Android™ device.- Select Search- Type in "HubbleConnect for SmartNursery"- The results will show the Hubble App- Select to install it <p>iOS Device:</p> <ul style="list-style-type: none">- Open the App StoreSM- Select Search- Type in "HubbleConnect for SmartNursery"- The results will show the Hubble App- Select to install it |
| Functions | Why there is little or no mist? | <ol style="list-style-type: none">1. May be the water level is too low, please refill water in the reservoir.2. Place the device on a flat and level surface.3. Change to a higher mist level (there are 4 selectable levels). |
| Functions | Why do I hear some vibrating noise? | <ol style="list-style-type: none">1. May be the water level is too low, please refill water in the reservoir.2. Place the device on a flat and level surface. |
| Functions | Why do I have a smelly mists? | It might be due to few causes: Mildew and Mold, Bacteria Growth, Mineral Deposits. Please clean the Device properly and replace with fresh water. |

8. Disposal of the Device (Environment)

At the end of the product life cycle, you should not dispose of this product with normal household waste. Take this product to a collection point for the recycling of electrical and electronic equipment. The symbol on the product, user's guide and/or box indicates this.



Some of the product materials can be re-used if you take them to a recycling point. By reusing some parts or raw materials from used products you make an important contribution to the protection of the environment.

Please contact your local authorities in case you need more information on the collection points in your area.

Dispose of the battery pack in an environmentally-friendly manner according to your local regulations.

9. General Information

If your product is not working properly....

1. Read this User's Guide.
2. Visit our website: www.motorolahome.com/support
3. Contact Customer Service at

+44 (0) 844 557 0890(UK only)*

*Calls cost 7p per minute plus your telephone company's access charge

+44 (0) 8187 62092 (ROI)

Consumer Products and Accessories Limited Warranty ("Warranty")

Thank you for purchasing this Motorola branded product manufactured under license by Binatone Electronics International Ltd ("BINATONE").

What Does this Warranty Cover?

Subject to the exclusions contained below, BINATONE warrants that this Motorola branded product ("Product") or certified accessory ("Accessory") sold for use with this product is manufactured to be free from defects in materials and workmanship under normal consumer usage for the period outlined below. This Warranty is your exclusive warranty and is not transferable.

Who is covered?

This Warranty extends only to the first consumer purchaser, and is not transferable.

What will BINATONE do?

BINATONE or its authorised distributor at its option and within a commercially reasonable time, will at no charge repair or replace any Products or Accessories that does not conform to this Warranty. We may use functionally equivalent reconditioned/ refurbished/ pre-owned or new Products, Accessories or parts.

What Other Limitations Are There?

ANY IMPLIED WARRANTIES, INCLUDING WITHOUT LIMITATION THE IMPLIED WARRANTIES OF MERCHANTABILITY AND FITNESS FOR A PARTICULAR PURPOSE, SHALL BE LIMITED TO THE DURATION OF THIS LIMITED WARRANTY, OTHERWISE THE REPAIR OR REPLACEMENT PROVIDED UNDER THIS EXPRESS LIMITED WARRANTY IS THE EXCLUSIVE REMEDY OF THE CONSUMER, AND IS PROVIDED IN LIEU OF ALL OTHER WARRANTIES, EXPRESS OR IMPLIED. IN NO EVENT SHALL MOTOROLA OR BINATONE BE LIABLE, WHETHER IN CONTRACT OR TORT (INCLUDING NEGLIGENCE) FOR DAMAGES IN EXCESS OF THE PURCHASE PRICE OF THE PRODUCT OR ACCESSORY, OR FOR ANY INDIRECT, INCIDENTAL, SPECIAL OR CONSEQUENTIAL DAMAGES OF ANY KIND, OR LOSS OF REVENUE OR PROFITS, LOSS OF BUSINESS, LOSS OF INFORMATION OR OTHER FINANCIAL LOSS ARISING OUT OF OR IN CONNECTION WITH THE ABILITY OR INABILITY TO USE THE PRODUCTS OR ACCESSORIES TO THE FULL EXTENT THESE DAMAGES MAY BE DISCLAIMED BY LAW.

Some jurisdictions do not allow the limitation or exclusion of incidental or consequential damages, or limitation on the length of an implied warranty, so the above limitations or exclusions may not apply to you. This Warranty gives you specific legal rights, and you may also have other rights that vary from one jurisdiction to another.

| Products Covered | Length of Coverage |
|---|--|
| Consumer Products | One (1) year from the date of the Products, original purchase by the first consumer purchaser of the product. |
| Consumer Accessories | Ninety (90) days from the date of the Accessories, original purchase by the first consumer purchaser of the product. |
| Consumer Products and Accessories that are Repaired or Replaced | The balance of the original warranty or for Ninety (90) days from the date returned to the consumer, whichever is longer. |

Exclusions

Normal Wear and Tear. Periodic maintenance, repair and replacement of parts due to normal wear and tear are excluded from coverage.

Batteries. Only batteries whose fully charged capacity falls below 80% of their rated capacity and batteries that leak are covered by this Warranty.

Abuse & Misuse. Defects or damage that result from: (a) improper operation, storage, misuse or abuse, accident or neglect, such as physical damage (cracks, scratches, etc.) to the surface of the product resulting from misuse; (b) contact with liquid, water, rain, extreme humidity or heavy perspiration, sand, dirt or the like, extreme heat, or food; (c) use of the Products or Accessories for commercial purposes or subjecting the Product or Accessory to abnormal usage or conditions; or (d) other acts which are not the fault of MOTOROLA or BINATONE, are excluded from coverage.

Use of Non-Motorola branded Products and Accessories. Defects or damage that result from the use of Non-Motorola branded or certified Products or Accessories or other peripheral equipment are excluded from coverage.

Unauthorised Service or Modification. Defects or damages resulting from service, testing, adjustment, installation, maintenance, alteration, or modification in any way by someone other than MOTOROLA, BINATONE or its authorised service centres, are excluded from coverage.

Altered Products. Products or Accessories with (a) serial numbers or date tags that have been removed, altered or obliterated; (b) broken seals or that show evidence of tampering; (c) mismatched board serial numbers; or (d) nonconforming or non-Motorola branded housings, or parts, are excluded from coverage.

Communication Services. Defects, damages, or the failure of Products or Accessories due to any communication service or signal you may subscribe to or use with the Products or Accessories is excluded from coverage.

How to Obtain Warranty Service or Other Information?

To obtain service or information, please call:

+44 (0) 844 557 0890 (UK only)*

**Calls cost 7p per minute plus your telephone company's access charge*

+44 (0) 8187 62092 (ROI)

You will receive instructions on how to ship the Products or Accessories at your expense and risk, to a BINATONE Authorised Repair Centre.

To obtain service, you must include: (a) the Product or Accessory; (b) the original proof of purchase (receipt) which includes the date, place and seller of the Product; (c) if a warranty card was included in your box, a completed warranty card showing the serial number of the Product; (d) a written description of the problem; and, most importantly; (e) your address and telephone number.

These terms and conditions constitute the complete warranty agreement between you and BINATONE regarding the Products or Accessories purchased by you, and supersede any prior agreement or representations, including representations made in any literature publications or promotional materials issued by BINATONE or representations made by any agent employee or staff of BINATONE, that may have been made in connection with the said purchase.



BINATONE TELECOM PLC

1 Apsley Way London NW2 7HF, United Kingdom.
Tel: +44(0) 20 8955 2700 Fax: +44(0) 20 8344 8877
e-mail: binatoneuk@binatone telecom.com.uk

EC Declaration of Conformity

We the manufacturer / Importer: Binatone Telecom Plc
1 Apsley Way London
NW2 711F, United Kingdom.

Declare under our sole responsibility that the following product
Type of equipment: Scale with Bluetooth function
Model Name: CARE400
Country of Origin: China
Brand: Motorola

complies with the essential protection requirements of R&TTE Directive 1999/5/EC on the approximation of the laws of the Member States relating to Radio Spectrum Matters, the Council Directive 2004 /108/EC on the approximation of the laws of the Member States relating to *electromagnetic compatibility (EMC)* and the European Community Directive 2006/95/EC relating to Electrical Safety. Directive 2011/65/EC on the *restriction of use of hazardous substances (RoHS)* and 2009/125/EC relating to ecodesign requirement for *Energy-Related Products (ErP)*.

Assessment of compliance of the product with the requirements relating to the essential requirements according to Article 3 R&TTE was based on Annex III of the Directive 1999/5/EC and the following standard:

Radio Spectrum: EN300328 v1.9.1
EMC: EN301489-17 v2.2.1, EN 301489-1 v1.9.2
EN55014-1, EN55014-2
Electrical Safety: EN60950-1:2006+A11:2009+A1:2010+A12:2011+A2:2013

The product is labelled with the European Approval Marking CE as show. Any unauthorised modification of the product voids this Declaration.

Manufacturer / Importer
(Signature of authorised person)



London, 30 June 2016

Karl Heinz Mueller / Chief Technical Officer

Place & Date



10. Technical Specifications

| | |
|-----------------------|-----------------------------------|
| Power | 100-240V AC |
| Operating Temperature | -10 to 50°C |
| Wi-Fi | 2.4G Wi-Fi 802.11 b/g/n supported |
| Mist Rate | 280 – 380 ml/h |



Manufactured, distributed or sold by Binatone Electronics International LTD., official licensee for this product. MOTOROLA and the Stylised M logo are trademarks or registered trademarks of Motorola Trademark Holdings, LLC, and are used under license. Apple logo is a trademark of Apple Inc., registered in the U.S. and other countries. App Store is a service mark of Apple Inc. Google Play and Android are trademarks of Google Inc. Wi-Fi is a trademark of the Wi-Fi Alliance. All other trademarks are the property of their respective owners. © 2016 Motorola Mobility LLC. All rights reserved.



UK_EN Version 1.0

Printed in China